

SmartVerge® Dry Verge System - Dry Verge Units

Code: **GDV**

**Product Codes:**

Dry Verge Unit (Right Hand) GDV-RH  
 Dry Verge Unit (Left Hand) GDV-LH

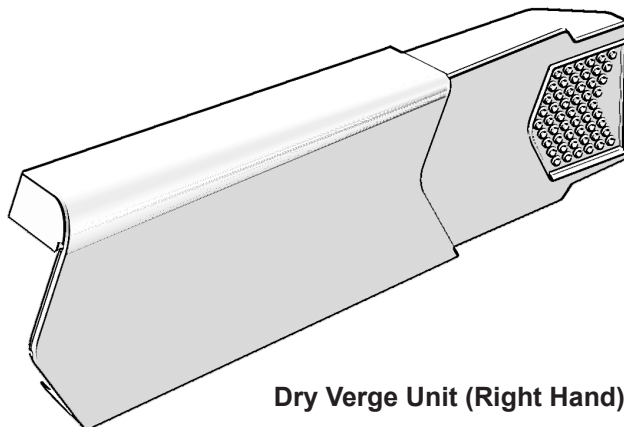

**Dry Verge Unit (Right Hand)**

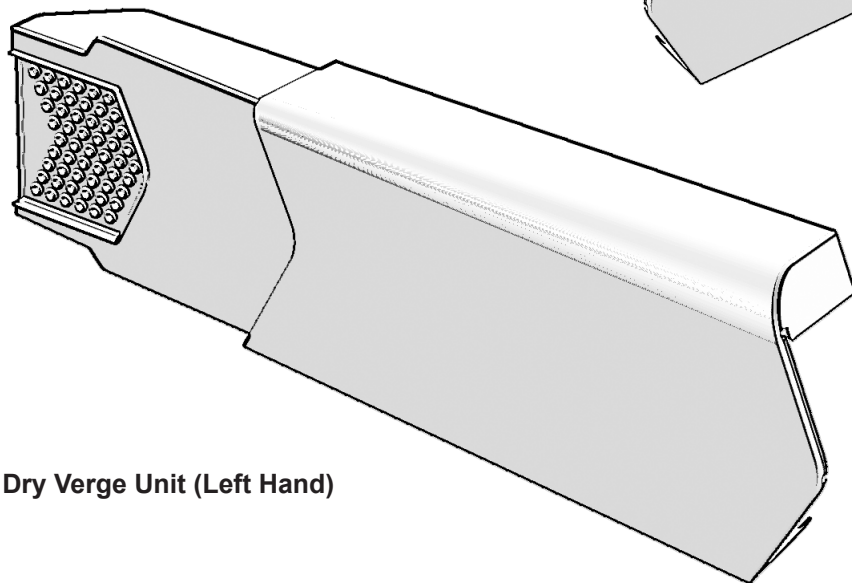

**Dry Verge Unit (Left Hand)**

**Description:**

The Manthorpe Dry Verge System provides an attractive finish to the verge detail for most makes and profiles of Concrete Interlocking Tiles laid between 280mm and 345mm batten gauge.

The Verge Units can be easily fitted to each tile in succession. The system is mortar-free and can be fixed in all weather conditions. Once fitted they are weatherproof and maintenance free.

The Manthorpe Dry Verge is available in Terracotta, Dark Brown, Slate Grey and White to compliment any variation of roof design. The Dry Verge system preserves the 'stepped' appearance of the roof tiles while maintaining the continuous line on the underside of the verge.

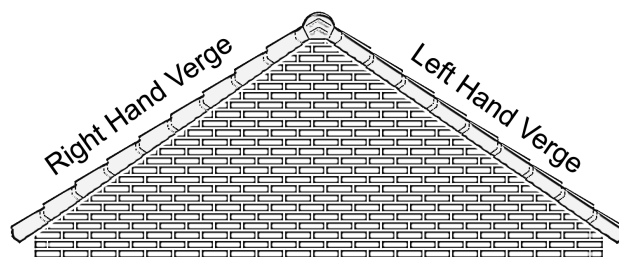

Illustration shows left and right hand verge units as viewed from outside the building.  
 Note: careful attention should be taken when specifying 'left' and 'right.'

MANTHORPE BUILDING PRODUCTS LTD  
 MANTHORPE HOUSE  
 BRITAIN DRIVE  
 CODNOR GATE BUSINESS PARK  
 RIPLEY  
 DERBYSHIRE DE5 3ND

TEL: 01773 303 000  
 FAX: 01773 303 300  
 EMAIL: mbp.care@manthorpebp.co.uk  
 WEB: www.manthorpebp.co.uk

| DRAWN         | ISSUE DRAWN     |
|---------------|-----------------|
| R.P. 14.02.05 | B.H. 10/03/2022 |

The company maintains a policy of continuous development of its product range and reserves the right to amend the specification without notice.

DRG No

**MBP 8226**

Issue

**08**  
1 of 2

SmartVerge® Dry Verge System - Dry Verge Units

Code: **GDV**

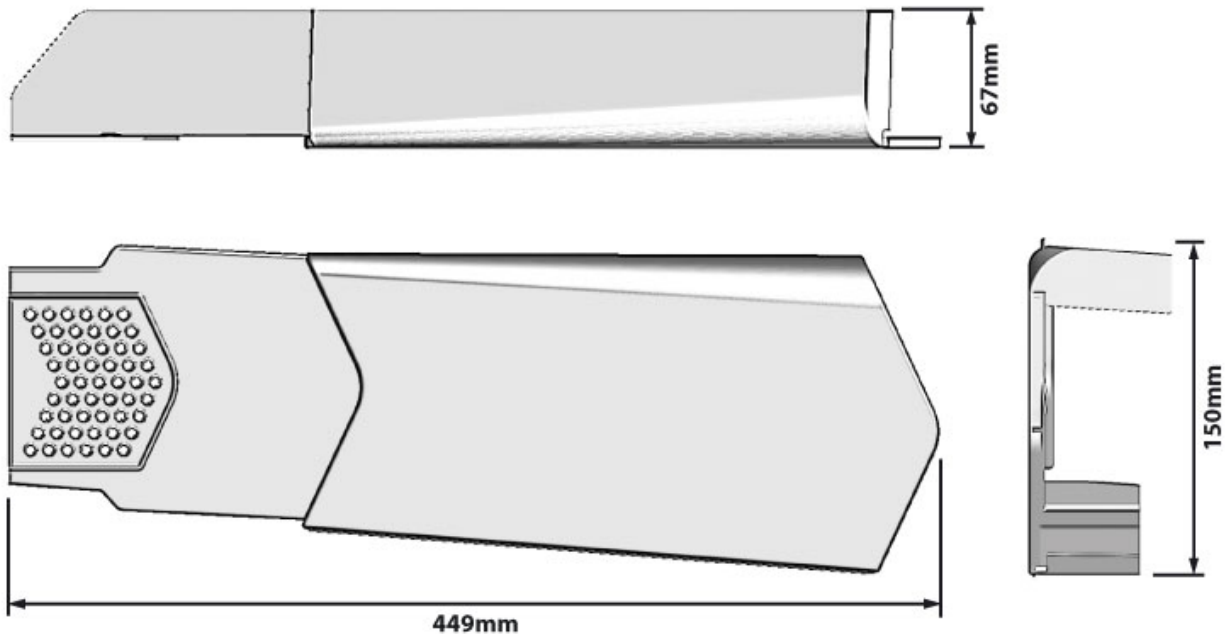

### Guidance:















At the eaves, each run of Dry Verge units should be closed off at the bottom using an Eaves Closure Unit (GDV-EC or GDV-REC) to prevent the ingress of birds and large insects.

At the ridge, the Manthorpe Angled or Round Ridge End Cap (GDV-END-A or GDV-END-R) should be used to prevent the ingress of birds and large insects. At a top edge abutment or similar, a lead flashing should be dressed over the tail of the top verge unit. The length of flashing will be dependent on the pitch.

For further installation guidance, refer to the products fitting instructions.

### BS 8612 Specifications

- Independently tested to conform with the requirements of BS 8612.
- Performance data for the tests conducted on this product is available upon request.

|                            |  |                 |   |                 |   |                 |   |            |   |            |   |
|----------------------------|--|-----------------|---|-----------------|---|-----------------|---|------------|---|------------|---|
| BATTEN GAUGE COMPATABILITY | 280mm to 345mm   |                 |   |                 |   |                 |   |            |   |            |   |
| ROOF PITCH COMPATABILITY   | 15° to 55°   |                 |   |                 |   |                 |   |            |   |            |   |
| PACKING DETAILS            | Dry Verge pack contains 10 left or right handed verge units<br><b>3 Packs per Box (30 units total)</b>   |                 |   |                 |   |                 |   |            |   |            |   |
| WEIGHT                     | 14.5kg per Box   |                 |   |                 |   |                 |   |            |   |            |   |
| MATERIAL                   | Unplasticized Polyvinyl Chloride (uPVC)  |                 |   |                 |   |                 |   |            |   |            |   |
| MANUFACTURING PROCESS      | Injection Moulded  |                 |   |                 |   |                 |   |            |   |            |   |
| COLOUR VARIATIONS          | <table border="0"> <tr> <td>Terracotta (TR)</td> <td></td> </tr> <tr> <td>Dark Brown (BR)</td> <td></td> </tr> <tr> <td>Slate Grey (GR)</td> <td></td> </tr> <tr> <td>White (WH)</td> <td></td> </tr> <tr> <td>Black (BL)</td> <td></td> </tr> </table> | Terracotta (TR) |  | Dark Brown (BR) |  | Slate Grey (GR) |  | White (WH) |  | Black (BL) |  |
| Terracotta (TR)            |   |                 |   |                 |   |                 |   |            |   |            |   |
| Dark Brown (BR)            |   |                 |   |                 |   |                 |   |            |   |            |   |
| Slate Grey (GR)            |   |                 |   |                 |   |                 |   |            |   |            |   |
| White (WH)                 |   |                 |   |                 |   |                 |   |            |   |            |   |
| Black (BL)                 |   |                 |   |                 |   |                 |   |            |   |            |   |

MANTHORPE BUILDING PRODUCTS LTD  
MANTHORPE HOUSE  
BRITAIN DRIVE  
CODNOR GATE BUSINESS PARK  
RIPLEY  
DERBYSHIRE DE5 3ND

TEL: 01773 303 000  
FAX: 01773 303 300  
EMAIL:  
mbp.care@manthorpebp.co.uk  
WEB:  
www.manthorpebp.co.uk

| DRAWN         | ISSUE DRAWN     |
|---------------|-----------------|
| R.P. 14.02.05 | B.H. 10/03/2022 |

The company maintains a policy of continuous development of its product range and reserves the right to amend the specification without notice.

DRG No

**MBP 8226**

Issue

**08**  
2 of 2